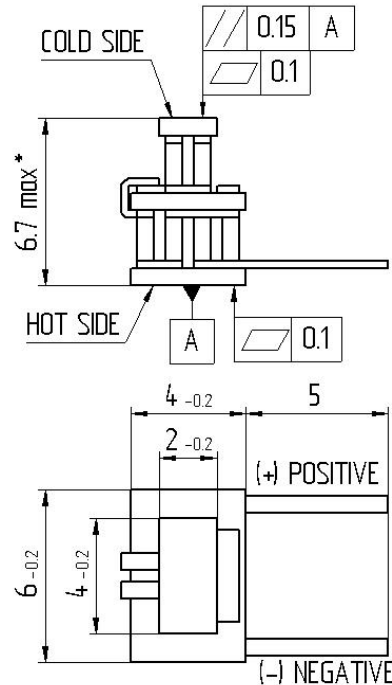
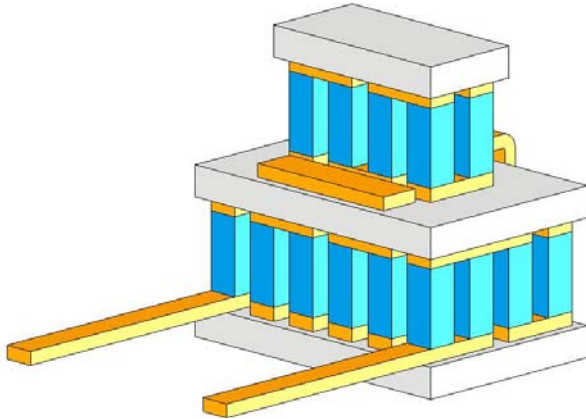

**SPECIFICATION OF THERMOELECTRIC MODULE TB-2-(11-4)-1.5**

\*Tolerance of the TEC's height for a lot is  $\pm 0.35$  mm

Thermoelectric parameters	Unit	Value
<b>I<sub>max</sub></b>	<b>Amps</b>	<b>1.0</b>
<b>U<sub>max</sub></b>	<b>Volts</b>	<b>1.3</b>
<b>ΔT<sub>max</sub></b>	<b>K</b>	<b>93</b>
<b>Q<sub>max</sub></b>	<b>Watts</b>	<b>0.4</b>
<b>Tolerance</b>	<b>%</b>	<b>±10</b>

*All parameters except R<sub>ac</sub> are given at Th=300 K*

Assembly parameters	Unit	Value
<b>Wires</b>	-	-
<b>Cross section</b>	<b>mm<sup>2</sup></b>	-
<b>Metallization</b>	-	<b>Not</b>
<b>Sealing</b>	-	<b>Not</b>
<b>Internal solder</b>	<b>°C</b>	<b>139</b>
<b>Brazing solder</b>	<b>°C</b>	<b>not</b>

Operation parameters	Unit	Value
<b>Working temperature range</b>	<b>°C</b>	<b>-50 ÷ +80</b>
<b>Max. processing temperature</b>	<b>°C</b>	<b>120</b>
<b>ROHS compliance</b>	-	<b>YES</b>

